

## ACCESSORI ATLANTIS 55TT "VARI"

sigla	profilo	descrizione
Ra 1033		CAPPETTA DI DRENAGGIO
Ra 1404		REGOLATORE A MURO
Ra 1420		CAVALLOTTO PER AZ5206
Ra 1421		CAVALLOTTO PER AZ5256
Ra 1422		ANGOLI PER FERMAVETRI ARROTONDATI
Ra 2601		BOCCOLA SCARICO ACQUA
Ra 1737		CLIP PER FERMAVETRI





## ACCESSORI ATLANTIS 55TT "SQUADRETTE"

sigla	profilo	descrizione
Ra 1048		SQUADRETTA PRESSOFUSA A TIRAGGIO ESTERNO
Ra 1411		SQUADRETTA DI ALLINEAMENTO PER IMBOTTI CAPANNONI
Ra 1423		SPINA DA 13,5 mm
Ra 1702		SQUADRETTA DI ALLINEAMENTO PER SEDE GUARNIZIONE TELAI
Ra 1704		SQUADRETTA DI ALLINEAMENTO
Ra 1705		SQUADRETTA A SPINARE CASSA INTERNA
Ra 1706		SQUADRETTA A TIRAGGIO MECCANICO CASSA INTERNA
Ra 1707		SQUADRETTA A SPINARE CASSA INTERNA PER PROFILI MAGGIORATI
Ra 1708		SQUADRETTA A TIRAGGIO MECCANICO CASSA INTERNA PER PROFILI MAGGIORATI
Ra 1710		SQUADRETTA DI ALLINEAMENTO CASSA ESTERNA
Ra 1711		SQUADRETTA A CIANFRINARE CASSA INTERNA



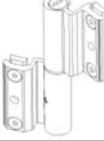

## ACCESSORI ATLANTIS 55TT "VARI"

sigla	profilo	descrizione
Ra 1712		SQUADRETTA A CIANFRINARE CASSA ESTERNA PER AZ5208 e AZ5225
Ra 1713		SQUADRETTA A CIANFRINARE CASSA ESTERNA PER AZ5242 e AZ5247
Ra 1714		SQUADRETTA A CIANFRINARE CASSA INTERNA PER AZ5242 e AZ5247



## ACCESSORI ATLANTIS 55TT "CERNIERE"

sigla	profilo	descrizione
Ra 1427		CERNIERA FLASH BASE
Ra 1428		CERNIERA FLASH BASE PER SOLUZIONE COMPLANARE O 3° ANTA
Ra 1430		CERNIERA PER PORTE FLASH XL
Ra 1431		CERNIERE PER PORTE FLASH XL SOL. COMPLANARE O 3° ANTA
Ra 1440		CERNIERA PER VASISTAS

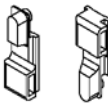
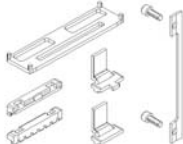







**ACCESSORI ATLANTIS 55TT "CREMONESI"**

sigla	profilo	descrizione
Ra 1031		CREMONESE UNICA
Ra 1055		CREMONESE "DOMINGA" PER AZ 5251
Ra 1056		CREMONESE PRIMA
Ra 1057		CREMONESE PRIMA 900 PER ANTA RIBALTA
Ra 1429		CRICCHETTO CICO
Ra 1447		BLOCCHETTI DI COLLEGAMENTO PER CREMONESE PRIMA Ra 1056
Ra 1454		BLOCCHETTI DI COLLEGAMENTO CON VITI DA ABBINARE A Ra 1031 PER APERTURA INTERNA

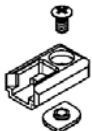
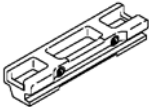
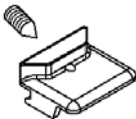
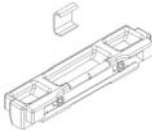







**ACCESSORI ATLANTIS 55TT "TAPPI"**

sigla	profilo	descrizione
Ra 1700		TAPPO PER RISCONTRO CENTRALE AZ5203 (GIUNTO APERTO)
Ra 1701		TAPPO DI FINITURA SUPERIORE SERIE PORTE

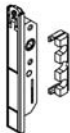
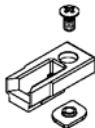



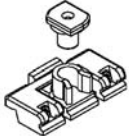

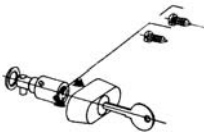

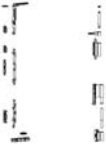

## ACCESSORI ATLANTIS 55TT "ACCESSORI DI CHIUSURA"

sigla	profilo	descrizione
Ra 1002		TERMINALE PER ASTE
Ra 1035		CATENACCIO GIAP IN NYLON
Ra 2905		INCONTRO ASTE E TERZA CHIUSURA IN ZAMA
Ra 2906		INCONTRO SINGOLO DOPPIO IN NYLON
Ra 2907		INCONTRO PER art. Ra 2918
Ra 2908		INCONTRO DOPPIO IN ZAMA
Ra 2909		ROSTRO DI CHIUSURA REGISTRABILE SU LATO CERNIERA
Ra 2910		BRACCIO LIMITATORE DI APERTURA FRIZ
Ra 2911		BRACCIO LUNGO RALLENTY mm250
Ra 2912		BRACCIO CORTO RALLENTY mm150
Ra 2913		CATENACCIO CON PUNTALE ECCENTRICO REGISTRABILE

## ACCESSORI ATLANTIS 55TT "ACCESSORI DI CHIUSURA"



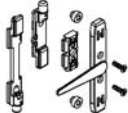



sigla	profilo	descrizione
Ra 2914		TAPPO SOSTENIMENTO ANTE
Ra 2915		MARTELLINA MASTERMAR
Ra 2918		NOTTOLINO DI CHIUSURA SUPPLEMENTARE
Ra 1433		MOVIMENTAZIONE INTERNA BIDIREZIONALE
Ra 1436		INCONTRO DOPPIO E TERZA CHIUSURA IN NYLON
Ra 1437		INCONTRO SINGOLO IN ZAMA
Ra 1441		TERMINALE REGISTRABILE CON PUNTALE ECCENTRICO
Ra 1444		CATENACCIO BIDIREZIONALE A LEVA
Ra 1445		FERMA ANTA
Ra 1452		ASTINA DI COLLEGAMENTO 15/20 IN POLIAMMIDE (Rotolo da 250m)
Ra 1457		SERRATURA DI BLOCCAGGIO

## ACCESSORI ATLANTIS 55TT "ANTA RIBALTA BASE"

sigla	profilo	descrizione
Ra 1458		MECC. BASE AR FUTURA
Ra 1459		BRACCIO TIPO 1 AR FUTURA
Ra 1460		BRACCIO TIPO 2 AR FUTURA
Ra 1461		CHIUSURA SUPPLEMENTARE FUTURA
Ra 2921		CATENACCIO REGISTRABILE ANTA ABBINATA
Ra 2922		CATENACCIO GIAP ANTA ABB. AD A/R IN NYLON
Ra 2923		BRACCIO SUPPLEMENTARE PER A/R
Ra 1456		CATENACCIO ANTA ABBINATA AD A/R
Ra 1443		CATENACCIO BID. A LEVA PER A/R
Ra 1435		MOVIMENTAZIONE INTERNA MONODIREZIONALE PER A/R
Ra 1462		CERNIERA ANTA ABBINATA A Ra 1458



**ACCESSORI ATLANTIS 55TT "ANTA RIBALTA PER SOLUZIONE COMPLANARE"**

sigla	profilo	descrizione
Ra 1455		MECCANISMO ANTA RIBALTA PER SOLUZIONE COMPLANARE
Ra 1025		CATENACCI ANTA ABBINATA APPLICABILE A RA 1455
Ra 1044		BRACCIO TIPO 1 A.R APPLICABILE A RA 1455
Ra 1045		BRACCIO TIPO 2 A.R APPLICABILE A RA 1455
Ra 2919		CHIUSURE SUPPL. VERTICALI APPLICABILE A RA 1455
Ra 2920		CHIUSURE SUPPL. ORIZZONTALI APPLICABILE A RA 1455

## ACCESSORI ATLANTIS 55TT "BILICO"

sigla	profilo	descrizione
Ra 1439		MANIGLIA A TAVELLINO "BRAVO 1" PER BILICO
Ra 2916		MARTELLINA LINEA PRIMA PER BILICO
Ra 1453		RINVIO AD ANGOLO PER CHIUSURA PERIMETRALE BILICO
Ra 1446		PERNO DI COLLEGAMENTO
Ra 1434		MOVIMENTAZIONE INTERNA BID. PER BILICO
Ra 1736		SNODO A FRIZIONE PER BILICO

## ACCESSORI ATLANTIS 55TT "SPORGERE"

sigla	profilo	descrizione
Ra 1729		BRACCIO PER SPORGERE
Ra 1730		MANIGLIA A TAVELLINO "BRAVO 1" PER SPORGERE
Ra 1731		KIT PER APERTURA ESTERNA MONODIREZIONALE







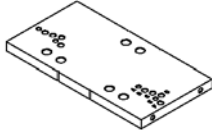
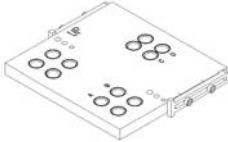

**ACCESSORI ATLANTIS 55TT "SPORGERE"**

sigla	profilo	descrizione
Ra 1732		TRAIANO PER ASTINA
Ra 1733		BRACCI LASER INOX
Ra 1734		BRACCI LASER ZINCATO

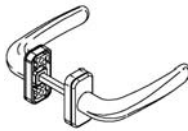

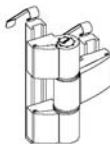
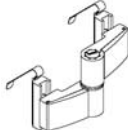
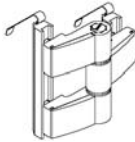







**ACCESSORI ATLANTIS 55TT "MONOBLOCCO"**

sigla	profilo	descrizione
Ra 1036		PASSACINTINO
Ra 1058		TAPPO RACCOGLI CONDENSA
Ra 1073		TAPPI CASSONETTO MONOBLOCCO
Ra 1419		COPPIA INVITI PER GUIDA TAPPARELLA
Ra 1476		KIT MOVIMENTAZIONE MONOBLOCCO

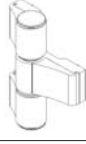
## ACCESSORI ATLANTIS 55TT "SERIE PORTA"

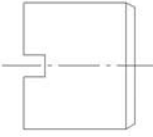
sigla	profilo	descrizione
Ra 1449		DIMA PER CERNIERE DOMINA
Ra 1450		DIMA PER CERNIERE DOMINA HP
Ra 1466		DOPPIA MANIGLIA PER MONTANTE
Ra 1467		DOPPIA MANIGLIA PER FASCIA
Ra 1715		CERNIERA DOMINA 2 ALI INT. 61 mm.
Ra 1716		CERNIERA DOMINA 3 ALI INT. 61 mm.
Ra 1717		CERNIERA DOMINA 2 ALI INT. 90,5 mm. PER APERTURA ESTERNA
Ra 1718		CERNIERA DOMINA 3 ALI INT. 90,5 mm. PER APERTURA ESTERNA
Ra 1719		BOCCOLE TELESCOPICHE PER CERNIERE Ra 1717 A Ra 1718
Ra 1720		VITI M4 X 40
Ra 1721		PUNTA DI FORATURA PER BOCCOLE

## ACCESSORI ATLANTIS 55TT "SERIE PORTA"

sigla	profilo	descrizione
Ra 1722		RONDELLA PER REGOLAZIONE IN ALTEZZA CERNIERE
Ra 1723		CHIAVE DI REGISTRAZIONE
Ra 1724		CERNIERA DOMINA HP 2 ALI INT. 62,5 mm.
Ra 1725		CERNIERA DOMINA HP 3 ALI INT. 62,5 mm.
Ra 1726		CERNIERA DOMINA HP 2 ALI INT. 84 mm. PER APERTURA ESTERNA
Ra 1727		CERNIERA DOMINA HP 3 ALI INT. 84 mm. PER APERTURA ESTERNA
Ra 1728		CLIP PER IL FISSAGGIO DEI PIASTRINI
Ra 2318		BOCCOLE TELESCOPICHE PER CERNIERE Ra 1726 e Ra 1727
Ra 2321		UTENSILE ALLARGATORE DA 11 mm. A 15 mm.
Ra 2323		CATENACCIO TOTEM PER SERIE PORTA
Ra 2324		INCONTRO PER CATENACCIO TOTEM Ra 2323

**ACCESSORI ATLANTIS 55TT "SERIE PORTA"**

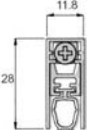
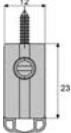
sigla	profilo	descrizione
Ra 2327		KIT DI TENUTA SOTTOZOCICOLO 1
Ra 2328		KIT DI TENUTA SOTTOZOCICOLO 2

**ACCESSORI ATLANTIS 55TT "SERIE PORTA"**

sigla	profilo	descrizione
Ra 1735		GRUPPO FRESA ATLANTIS 55TT
Ra 1074		PUNZONATRICE ATLANTIS

profilati scala ridotta

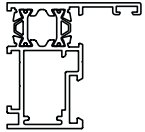
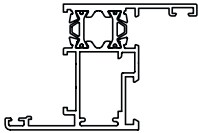
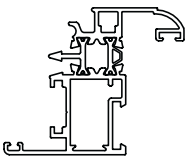
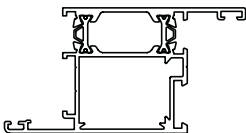
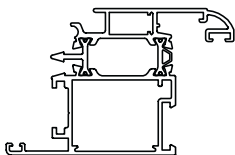
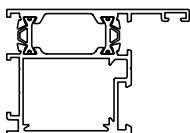
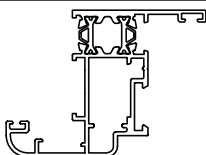
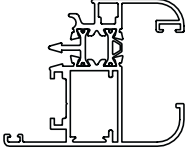
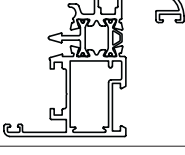
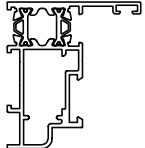
		CASSA ESTERNA		CASSA INTERNA			
	AZ 5201	Ra 1702	—	—	Ra 1711	Ra 1705	Ra 1706
	AZ 5202	Ra 1702	—	—	Ra 1711	Ra 1705	Ra 1706
	AZ 5204	Ra 1710	—	—	Ra 1711	Ra 1705	Ra 1706
	AZ 5207	Ra 1702	—	—	—	Ra 1707	Ra 1708
	AZ 5208	Ra 1704	Ra 1712	—	—	Ra 1707	Ra 1708
	AZ 5215	Ra 1702	—	—	—	Ra 1707	Ra 1708
	AZ 5216	Ra 1702	—	Ra 1704	Ra 1711	Ra 1705	Ra 1706
	AZ 5217	Ra 1710	—	—	Ra 1711	Ra 1705	Ra 1706
	AZ 5219	Ra 1710	—	—	Ra 1711	Ra 1705	Ra 1706
	AZ 5220	Ra 1702	—	—	Ra 1711	Ra 1705	Ra 1706

profilati scala ridotta

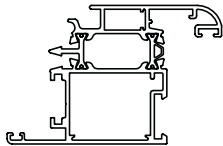
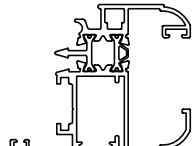
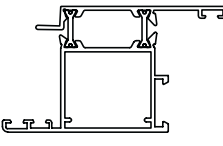
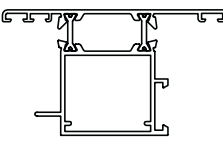
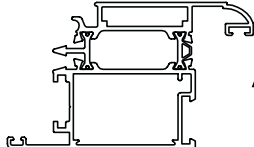
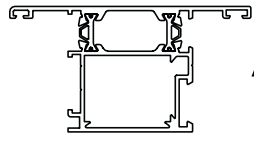
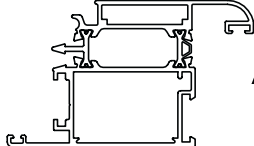
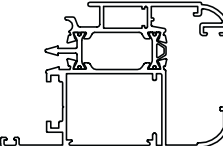
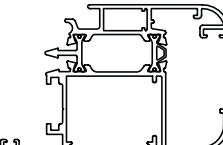
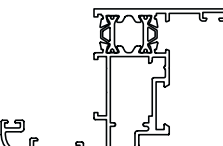
		CASSA ESTERNA		CASSA INTERNA			
	AZ 5225	Ra 1704	Ra 1712	—	—	Ra 1707	Ra 1708
	AZ 5226	Ra 1710	—	—	Ra 1711	Ra 1705	Ra 1706
	AZ 5237	—	—	—	—	Ra 1707	Ra 1708
	AZ 5238	—	—	—	—	Ra 1707	Ra 1708
	AZ 5242	—	Ra 1713	—	—	Ra 1714	—
	AZ 5245	Ra 1702	—	—	—	Ra 1707	Ra 1708
	AZ 5247	—	Ra 1713	—	—	Ra 1714	—
	AZ 5248	Ra 1704	Ra 1712	—	—	Ra 1707	Ra 1708
	AZ 5249	Ra 1704	Ra 1712	—	—	Ra 1707	Ra 1708
	AZ 5250	Ra 1702	—	Ra 1704	Ra 1711	Ra 1705	Ra 1706

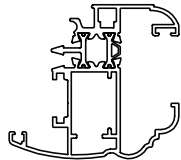
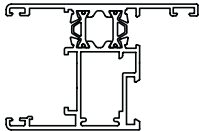
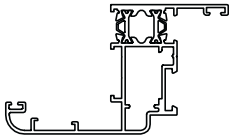
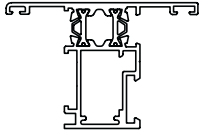
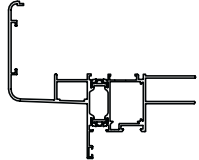
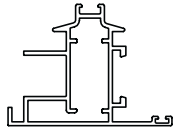
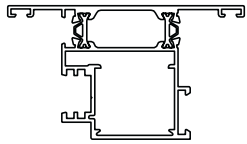
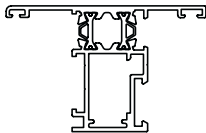
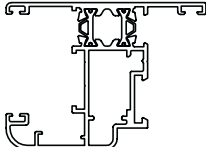
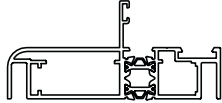

profilati scala ridotta

		CASSA ESTERNA		CASSA INTERNA			
	AZ 5251	Ra 1710	—	—	Ra 1711	Ra 1705	Ra 1706
	AZ 5252	Ra 1702	—	—	Ra 1711	Ra 1705	Ra 1706
	AZ 5254	Ra 1702	—	Ra 1704	Ra 1711	Ra 1705	Ra 1706
	AZ 5255	Ra 1702	—	—	Ra 1711	Ra 1705	Ra 1706
	AZ 5258	Ra 1411	Ra 1705 Ra 1706	—	—	Ra 1707	Ra 1708
	AZ 5259	—	—	—	Ra 1711	Ra 1705	Ra 1706
	AZ 5260	—	—	—	—	Ra 1707	—
	AZ 5261	Ra 1702	—	—	Ra 1711	Ra 1705	Ra 1706
	AZ 5262	Ra 1702	—	Ra 1704	Ra 1711	Ra 1705	Ra 1706
	AZ 5263	—	Ra 1048	—	—	—	H = 15 mm B = 17,5 mm

profilati scala ridotta

		CASSA ESTERNA		CASSA INTERNA			
	AZ 5267	Ra 1704	Ra 1711 Ra 1705 Ra 1706	—	—	—	—
	AZ 5268	Ra 1702	—	—	—	Ra 1707	Ra 1708
	AZ 4591	—	—	Ra 1411	—	—	Ra 1048
	AZ 4592	—	—	Ra 1411	—	—	Ra 1048
	AZ 4617	—	—	—	—	—	Ra 1048

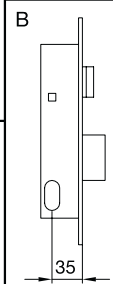
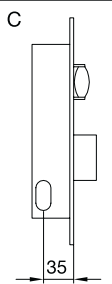
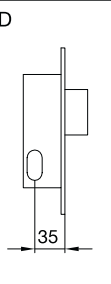
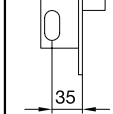
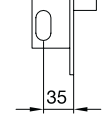
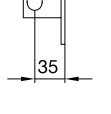
Serrature a montante (cilindro ovale)	 <p>44221-35-0 (scrocco + 1 mandata)</p>	 <p>44231-35-0 (rullo + 1 mandata)</p>	 <p>44241-35-0 (1 mandata)</p>
	 <p>44226-35-0 (scrocco + 2 mandate)</p>	 <p>44236-35-0 (rullo + 2 mandate)</p>	 <p>44246-35-0 (2 mandate)</p>

PORTA APERTURA INTERNA 1 ANTA

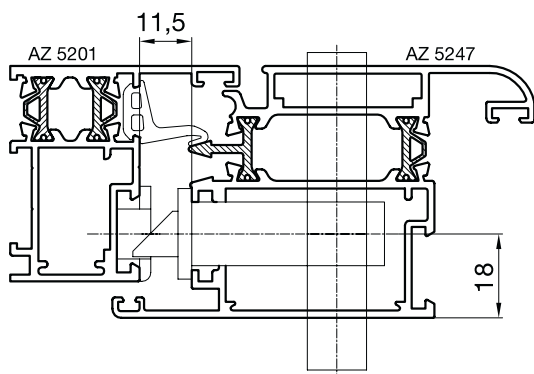

Cilindro	Contropiastra in nylon			Testata
	B	C	D	
08210-06-0 L=62.7 (27.7, 35)	06277-88	06277-90	06287-89	20

NB: Schema valido anche per porta a due ante

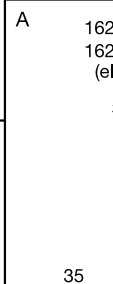
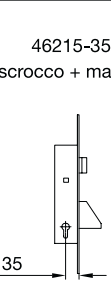
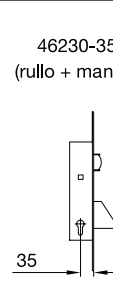
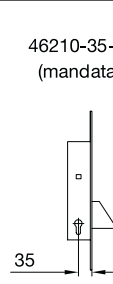
Serrature a montante (Catenaccio Basculante) 1 punto di chiusura	 <p>16215-35-0 16205-35-0 (elettrica)</p>	 <p>46215-35-0 (scrocco + mandata)</p>	 <p>46230-35-0 (rullo + mandata)</p>	 <p>46210-35-0 (mandata)</p>
------------------------------------------------------------------------	--------------------------------------------------------------------------------------------------------------------------------------	-------------------------------------------------------------------------------------------------------------------------------	-------------------------------------------------------------------------------------------------------------------------------	-----------------------------------------------------------------------------------------------------------------------

PORTA APERTURA INTERNA 1 ANTA

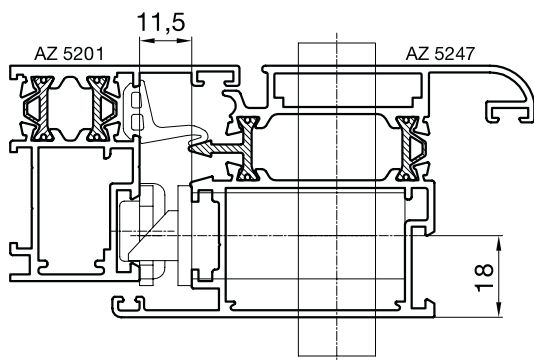

Cilindro Sagomato		Testata
Con borchie	Senza borchie	
0E300-11-0-12 L=69 (26.5-42.5)	0E300-11-0-12 L=69 (26.5-42.5)	22

Contropiastra regolabile in metallo		
A-B	C	D
06463-22	06463-22 (*)	06465-22
inserto per rullo 06141-71-0(*)		

NB: Schema valido anche per porta a due ante

**TABELLA UTILIZZO SERRATURE**

- Serrature per serie porta a giunto aperto (apertura interna) -

**Serrature di sicurezza montante ad ingranaggi (cilindro sagomato) 3 punti di chiusura**

<b>A</b> 18225-35-0 (elettrica)	<b>B</b> 48225-35-0 (scrocco + mandata)	<b>C</b> 48250-35-0 (rullo + mandata)	<b>D</b> 48220-35-0 (mandata)	<b>E</b> 06443-25-0 (aste esterne)
---------------------------------------	-----------------------------------------------	---------------------------------------------	-------------------------------------	------------------------------------------

**PORTA APERTURA INTERNA 1 ANTA**

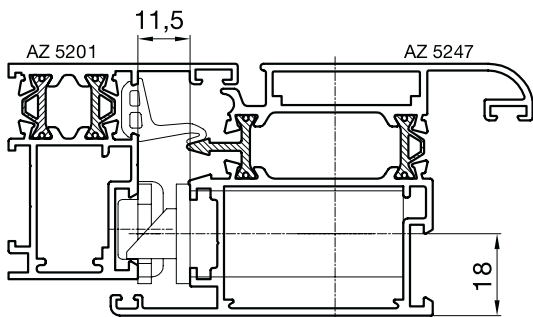

Cilindro Sagomato		Testata
Con borchie	Senza borchie	
0E300-11-0-12 L=69 (26.5-42.5)	0E300-11-0-12 L=69 (26.5-42.5)	22

Contropiastra regolabile in metallo			
A-B	C	D	E
06463-32	06463-32 (*)	06465-22	06465-32
inserto per rullo 06141-71 (*)			

NB: Schema valido anche per porta a due ante

**Serrature multitop (frontale "piatto")**

<b>A</b> 48525-35-0 (scrocco + mandata)  18525-35-0 (elettrica)	<b>B</b> 48550-35-0 (rullo + mandata)	<b>C</b> 48520-35-0 (mandata)
--------------------------------------------------------------------------------	---------------------------------------------	-------------------------------------

**PORTA APERTURA INTERNA 1 ANTA**

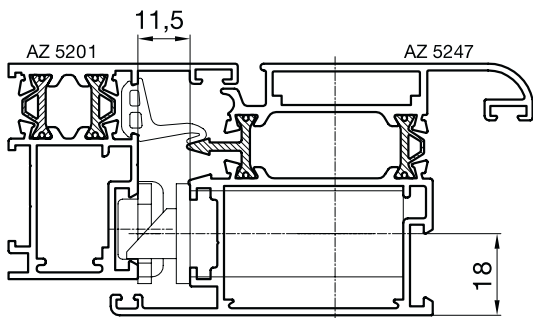

Cilindro Sagomato		Testata
Con borchie	Senza borchie	
0E300-11-0-12 L=69 (26.5-42.5)	0E300-11-0-12 L=69 (26.5-42.5)	24x3

Contropiastra regolabile in metallo			
A	B	C	Deviatori
06463-32	06463-32 (*)	06465-22	06465-32 (pz. 2)
inserto per rullo 06141-71 (*)			

NB: Schema valido anche per porta a due ante

**Serrature da fascia  
(cilindro ovale)**

A	14451-90-0 14461-90-0 (elettrica)	B	44461-90-0 (scrocco + mandata)	C	44471-90-0 (rullo + mandata)	D	44161-90-0 (vers. rullo)  44151-90-0 (vers. scrocco)
							

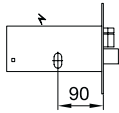
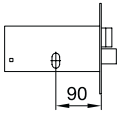
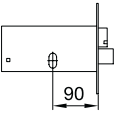
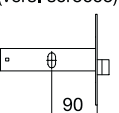

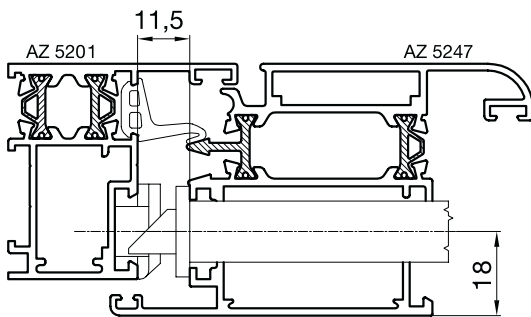
PORTA APERTURA INTERNA 1 ANTA



Cilindro	Contropiastra in nylon			Testata
	A-B	C	D	
08210-06-0	06277-89	06277-90	06287-89	20

NB: Schema valido anche per porta a due ante

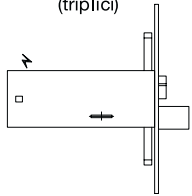
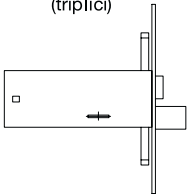
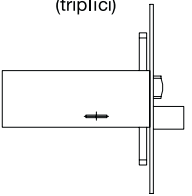
**Serrature da fascia  
a doppia mappa**

A	17357-10-0 (elettrica) (triplici)	B	57357-10-0 (scrocco + mandata) (triplici)	C	57365-10-0 (rullo + mandata) (triplici)	D	06443-05-0 (aste esterne)
							

PORTA APERTURA INTERNA 1 ANTA

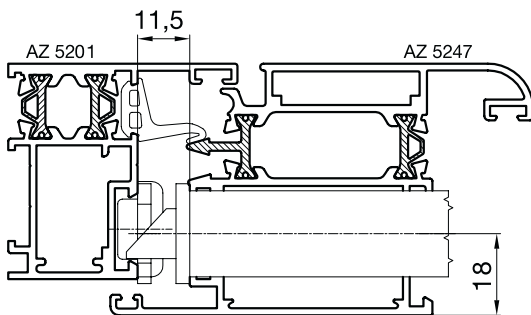

Contropiastra regolabile in metallo			Testata
A-B	C	D	
06465-22	06465-22 (*)	06465-22	22
inserto per rullo 06141-71 (*)			

NB: Schema valido anche per porta a due ante

**TABELLA UTILIZZO SERRATURE**

- Serrature per serie porta a doppia battuta (apertura interna) -

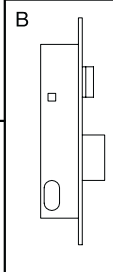
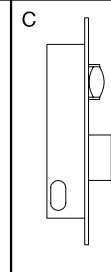
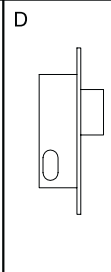
<b>Serrature a montante (cilindro ovale)</b>	 <b>B</b> 44221-30-0 (scrocco + 1 mandata)  44226-30-0 (scrocco + 2 mandate)	 <b>C</b> 44231-30-0 (rullo + 1 mandata)  44236-30-0 (rullo + 2 mandate)	 <b>D</b> 44241-30-0 (1 mandata)  44246-30-0 (2 mandate)
--------------------------------------------------	---------------------------------------------------------------------------------------------------------------------------------------------------------------------------------	-----------------------------------------------------------------------------------------------------------------------------------------------------------------------------	---------------------------------------------------------------------------------------------------------------------------------------------------------------

PORTA APERTURA INTERNA 1 ANTA

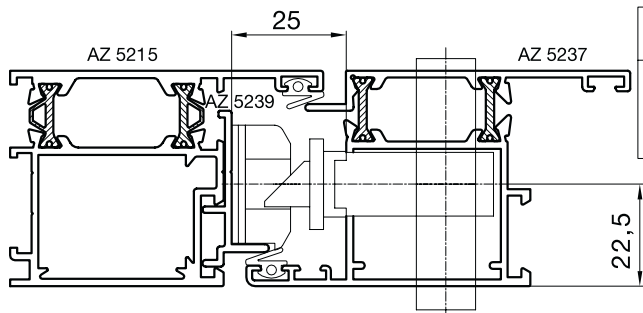

Cilindro	Contropiastra in nylon			Testata	Spessore
	B	C	D		
08210-02-0 L=55.4 (27.7, 27.7)	06277-94	06277-96	06287-95	20	06141-65

NB: Schema valido anche per porta a due ante

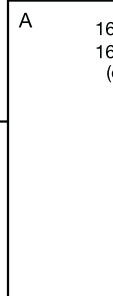
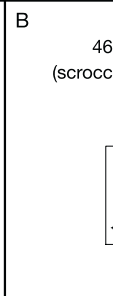
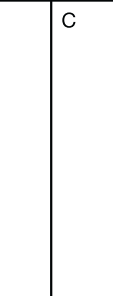
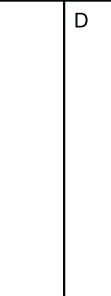
<b>Serrature a montante (Catenaccio Basculante) 1 punto di chiusura</b>	 <b>A</b> 16215-25-0 16205-25-0 (elettrica)	 <b>B</b> 46215-25-0 (scrocco + mandata)	 <b>C</b> 46230-25-0 (rullo + mandata)	 <b>D</b> 46210-25-0 (mandata)
---------------------------------------------------------------------------------	--------------------------------------------------------------------------------------------------------------------------------------------	--------------------------------------------------------------------------------------------------------------------------------------	-------------------------------------------------------------------------------------------------------------------------------------	------------------------------------------------------------------------------------------------------------------------------

PORTA APERTURA INTERNA 1 ANTA

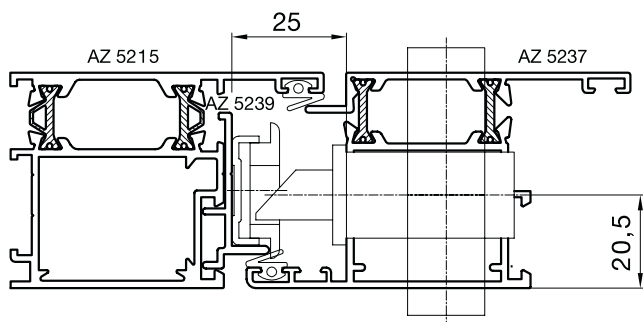

Cilindro Sagomato		Testata
Con borchie	Senza borchie	
0E300-08-0-12 L=59.2 (27.7-31.5)	0E300-05-0-12 L=55.4 (27.7-27.7)	22

Contropiastra regolabile in metallo		
A-B	C	D
06463-04	06463-04 (*)	06465-04
inserto per rullo 06141-70-0(*)		

NB: Schema valido anche per porta a due ante

TABELLA UTILIZZO SERRATURE

- Serrature per serie porta a doppia battuta (apertura interna) -

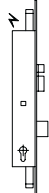
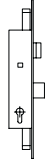
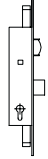
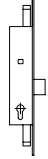
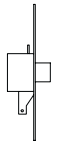
<p>Serrature di sicurezza montante ad ingranaggi (cilindro sagomato) 3 punti di chiusura</p>	<p><b>A</b></p> <p>18225-25-0 (elettrica)</p> 	<p><b>B</b></p> <p>48225-25-0 (scrocco + mandata)</p> 	<p><b>C</b></p> <p>48250-25-0 (rullo + mandata)</p> 	<p><b>D</b></p> <p>48220-25-0 (mandata)</p> 	<p><b>E</b></p> <p>06443-20-0 (aste interne)</p> 
----------------------------------------------------------------------------------------------	-------------------------------------------------------------------------------------------------------------------------------------	---------------------------------------------------------------------------------------------------------------------------------------------	--------------------------------------------------------------------------------------------------------------------------------------------	-------------------------------------------------------------------------------------------------------------------------------------	------------------------------------------------------------------------------------------------------------------------------------------

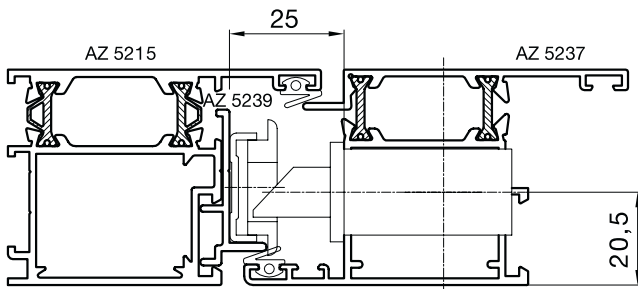

PORTA APERTURA INTERNA 1 ANTA



Cilindro Sagomato		Testata
Con borchie	Senza borchie	
0E300-08-0-12 L=59.2 (27.7-31.5)	0E300-05-0-12 L=55.4 (27.7-27.7)	22

Contropiastra regolabile in metallo			
A-B	C	D	E
06463-14	06463-14 (*)	06465-04	06465-14
inserto per rullo 06141-70 (*)			

NB: Schema valido anche per porta a due ante

<p>Serrature multitop (frontale a "U")</p>	<p><b>A</b></p> <p>48425-25-0 (scrocco + mandata)</p> <p>18425-25-0 (elettrica)</p> 	<p><b>B</b></p> <p>48450-25-0 (rullo + mandata)</p> 	<p><b>C</b></p> <p>48420-25-0 (mandata)</p> 
--------------------------------------------	---------------------------------------------------------------------------------------------------------------------------------------------------------------------------------	---------------------------------------------------------------------------------------------------------------------------------------------	---------------------------------------------------------------------------------------------------------------------------------------

PORTA APERTURA INTERNA 1 ANTA

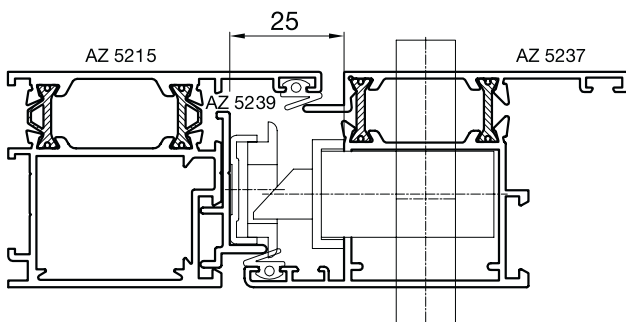

Cilindro Sagomato		Testata
Con borchie	Senza borchie	
0E300-08-0-12 L=59.2 (27.7-31.5)	0E300-05-0-12 L=55.4 (27.7-27.7)	24x7

Contropiastra regolabile in metallo			
A	B	C	Deviatori
06463-14	06463-14 (*)	06465-04	06465-14 (pz. 2)
inserto per rullo 06141-70 (*)			

NB: Schema valido anche per porta a due ante

**TABELLA UTILIZZO SERRATURE**

- Serrature per serie porta a doppia battuta (apertura interna) -

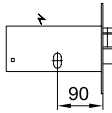
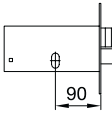
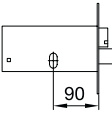
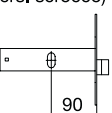
<p><b>Serrature da fascia (cilindro ovale)</b></p>	<p><b>A</b></p> <p>14451-90-0 14461-90-0 (elettrica)</p> 	<p><b>B</b></p> <p>44461-90-0 (scrocco + mandata)</p> 	<p><b>C</b></p> <p>44471-90-0 (rullo + mandata)</p> 	<p><b>D</b></p> <p>44161-90-0 (vers. rullo)</p> <p>44151-90-0 (vers. scrocco)</p> 
--------------------------------------------------------	----------------------------------------------------------------------------------------------------------------------------------------------------	---------------------------------------------------------------------------------------------------------------------------------------------	---------------------------------------------------------------------------------------------------------------------------------------------	-------------------------------------------------------------------------------------------------------------------------------------------------------------------------------

PORTA APERTURA INTERNA 1 ANTA

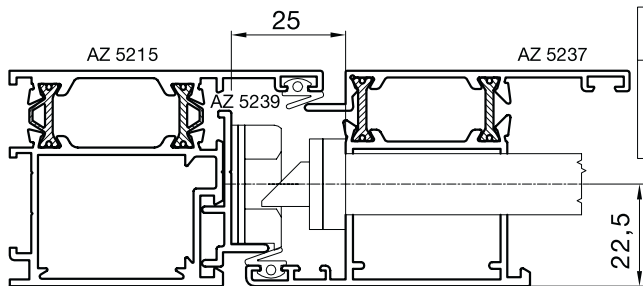

Cilindro	Contropiastra in nylon			Testata	Spessore
	A-B	C	D		
08210-02-0 L=55.4 (27.7, 27.7)	06277-95	06277-96	06287-95	20	06141-67

NB: Schema valido anche per porta a due ante

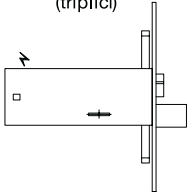
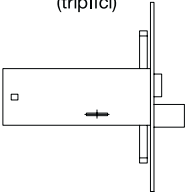
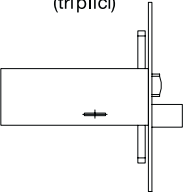
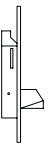
<p><b>Serrature da fascia a doppia mappa</b></p>	<p><b>A</b></p> <p>17357-90-0 (elettrica) (triplici)</p> 	<p><b>B</b></p> <p>57357-90-0 (scrocco + mandata) (triplici)</p> 	<p><b>C</b></p> <p>57365-90-0 (rullo + mandata) (triplici)</p> 	<p><b>D</b></p> <p>06443-00-0 (aste interne)</p> 
------------------------------------------------------	------------------------------------------------------------------------------------------------------------------------------------------------------	--------------------------------------------------------------------------------------------------------------------------------------------------------------	--------------------------------------------------------------------------------------------------------------------------------------------------------------	--------------------------------------------------------------------------------------------------------------------------------------------



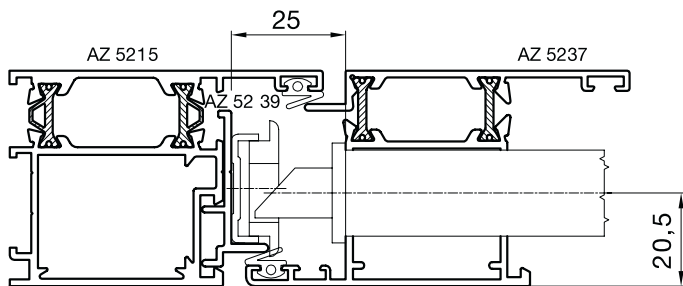

PORTA APERTURA INTERNA 1 ANTA

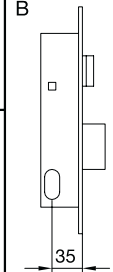
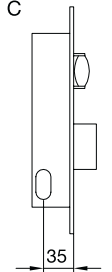
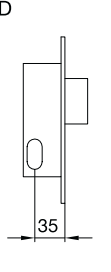

Contropiastra regolabile in metallo			Testata
A-B	C	D	
06465-04	06465-04 (*)	06465-04	22
inserto per rullo 06141-70 (*)			

NB: Schema valido anche per porta a due ante



<b>Serrature a montante (cilindro ovale)</b>	<b>B</b>  44221-30-0 (scrocco + 1 mandata)	<b>C</b>  44231-30-0 (rullo + 1 mandata)	<b>D</b>  44241-30-0 (1 mandata)
	44226-30-0 (scrocco + 2 mandate)	44236-30-0 (rullo + 2 mandate)	44246-30-0 (2 mandate)
	 35	 35	 35

PORTA APERTURA ESTERNA 1 ANTA

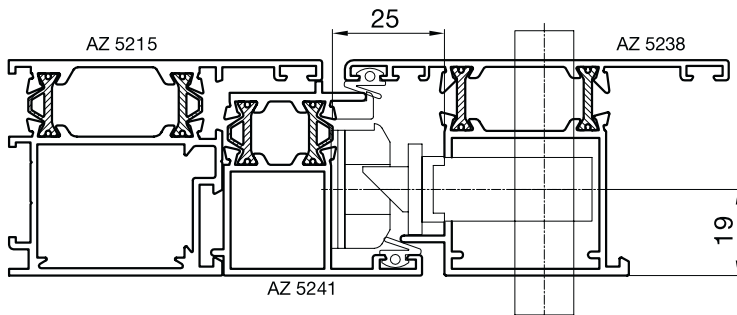

Cilindro	Contropiastra in nylon			Testata
	B	C	D	
08210-06-0 L=62.7 (27.7, 35)	06277-94	06277-96	06287-95	20
Spessore sotto frontale 06141-65	Salva Profilo 06141-79			

NB: Schema valido anche per porta a due ante

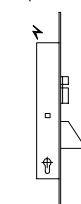
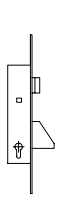
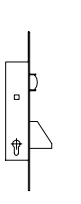
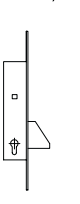
<b>Serrature a montante (Catenaccio Basculante) 1 punto di chiusura</b>	<b>A</b> 16215-25-0 16205-25-0 (elettrica)	<b>B</b> 46215-25-0 (scrocco + mandata)	<b>C</b> 46230-25-0 (rullo + mandata)	<b>D</b> 46210-25-0 (mandata)
				

PORTA APERTURA ESTERNA 1 ANTA

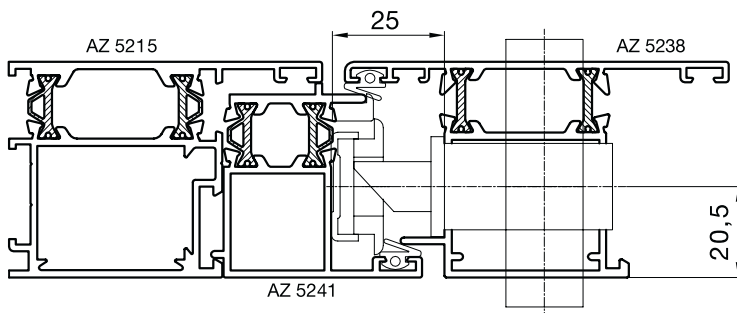

Cilindro Sagomato		Testata
Con borchie	Senza borchie	
0E300-08-0-12 L=59.2 (27.7-31.5)	0E300-05-0-12 L=55.4 (27.7-27.7)	22

Contropiastra regolabile in metallo			
A-B	C	D	Salva Profilo
06463-04	06463-04 (*)	06465-04	06141-79
inserto per rullo 06141-70-0(*)			

NB: Schema valido anche per porta a due ante

**TABELLA UTILIZZO SERRATURE**

- Serrature per serie porta a doppia battuta (apertura esterna) -

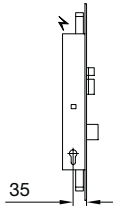
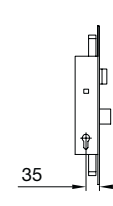
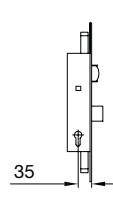
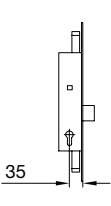
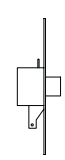
<p><b>Serrature di sicurezza montante ad ingranaggi (cilindro sagomato) 3 punti di chiusura</b></p>	<p><b>A</b> 18225-25-0 (elettrica)</p> 	<p><b>B</b> 48225-25-0 (scrocco + mandata)</p> 	<p><b>C</b> 48250-25-0 (rullo + mandata)</p> 	<p><b>D</b> 48220-25-0 (mandata)</p> 	<p><b>E</b> 06443-20-0 (aste interne)</p> 
	35	35	35	35	

**PORTA APERTURA ESTERNA 1 ANTA**

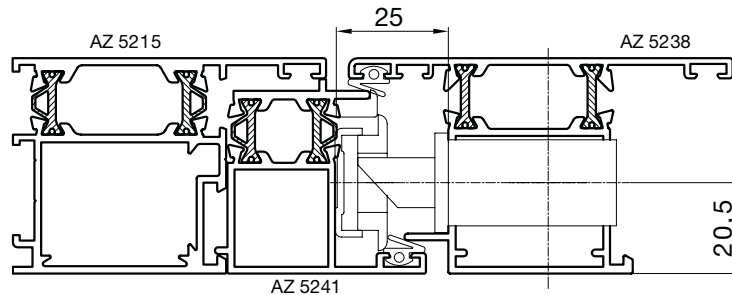

Cilindro Sagomato		Testata
Con borchie	Senza borchie	22
0E300-08-0-12 L=59.2 (27.7-31.5)	0E300-05-0-12 L=55.4 (27.7-27.7)	

Contropiastra regolabile in metallo				Salva Profilo
A-B	C	D	E	06141-79
06463-14	06463-14 (*)	06465-04	06465-14	
inserto per rullo 06141-70 (*)				

NB: Schema valido anche per porta a due ante

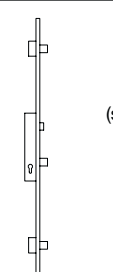
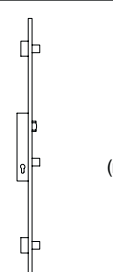
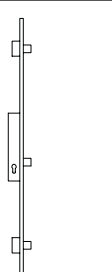
<p><b>Serrature multitop (frontale)</b></p>	<p><b>A</b> 48425-25-0 (scrocco + mandata)</p> 	<p><b>B</b> 48450-25-0 (rullo + mandata)</p> 	<p><b>C</b> 48420-25-0 (mandata)</p> 
	18425-25-0 (elettrica)		

**PORTA APERTURA ESTERNA 1 ANTA**

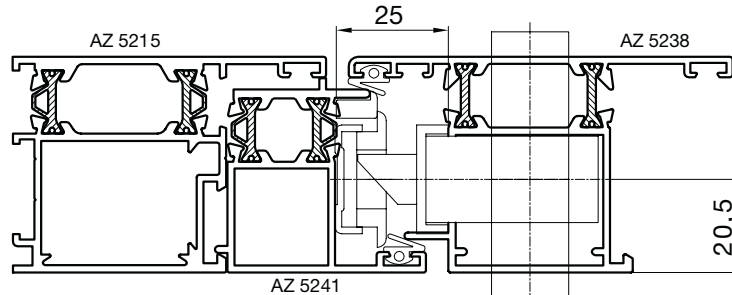

Cilindro Sagomato		Testata
Con borchie	Senza borchie	24x7
0E300-08-0-12 L=59.2 (27.7-31.5)	0E300-05-0-12 L=55.4 (27.7-27.7)	

Contropiastra regolabile in metallo				Salva Profilo
A	B	C	Deviatori	06141-79
06463-14	06463-14 (*)	06465-04	06465-14 (pz. 2)	
inserto per rullo 06141-70 (*)				

NB: Schema valido anche per porta a due ante

Serrature da fascia  
(cilindro ovale)

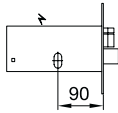
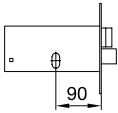
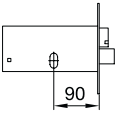
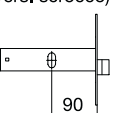
	<p><b>A</b></p> <p>14451-90-0 14461-90-0 (elettrica)</p> 	<p><b>B</b></p> <p>44461-90-0 (scrocco + mandata)</p> 	<p><b>C</b></p> <p>44471-90-0 (rullo + mandata)</p> 	<p><b>D</b></p> <p>44161-90-0 (vers. rullo)</p> <p>44151-90-0 (vers. scrocco)</p> 
--	----------------------------------------------------------------------------------------------------------------------------------------------------	---------------------------------------------------------------------------------------------------------------------------------------------	---------------------------------------------------------------------------------------------------------------------------------------------	-------------------------------------------------------------------------------------------------------------------------------------------------------------------------------

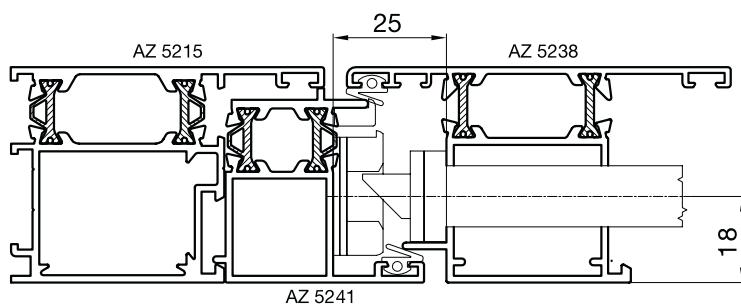

PORTA APERTURA ESTERNA 1 ANTA



Cilindro	Contropiastra in nylon			Testata
	A-B	C	D	
08210-02-0 L=55.4 (27.7, 27.7)	06277-95	06277-96	06287-95	20
Spessore sotto frontale 06141-67	Salva Profilo 06141-79			

NB: Schema valido anche per porta a due ante

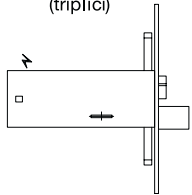
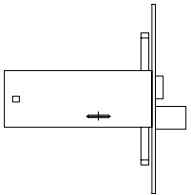
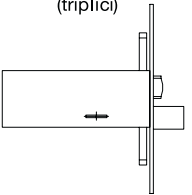
Serrature da fascia  
a doppia mappa

	<p><b>A</b></p> <p>17357-90-0 (elettrica) (triplici)</p> 	<p><b>B</b></p> <p>57357-90-0</p> 	<p><b>C</b></p> <p>57365-90-0 (rullo + mandata) (triplici)</p> 	<p><b>D</b></p> <p>06443-00-0 (aste interne)</p> 
--	------------------------------------------------------------------------------------------------------------------------------------------------------	-----------------------------------------------------------------------------------------------------------------------	--------------------------------------------------------------------------------------------------------------------------------------------------------------	--------------------------------------------------------------------------------------------------------------------------------------------

PORTA APERTURA ESTERNA 1 ANTA

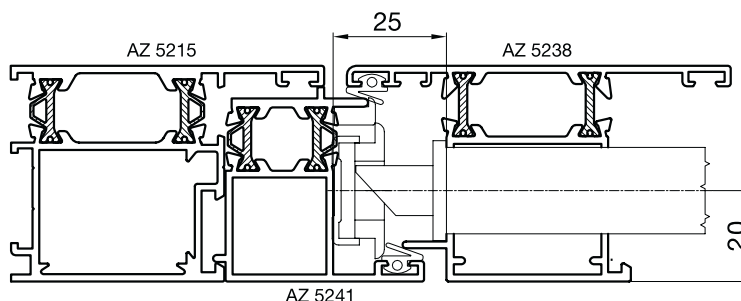

Contropiastra regolabile in metallo			Testata	Salva Profilo
A-B	C	D		
06465-04	06465-04 (*)	06465-04	22	06141-79
inserto per rullo 06141-70 (*)				

NB: Schema valido anche per porta a due ante









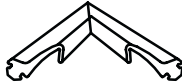

guarnizioni weatherstrips

atlantis  
serie 55TT











**TO.MA.** S.p.a.  
ESTRUSIONE ALLUMINIO

scala 1:1

Rg 401		Guarnizione di battuta porte Materiale EPDM	2 Rotoli da 300 m
Rg 402		Guarnizione di battuta interna Materiale EPDM	3 Rotoli da 300 m
Rg 330		Guarnizione centrale di tenuta Materiale EPDM	4 Rotoli da 50 m
Ra 1703		Angolo Vulcanizzato per Rg 330 Materiale EPDM	50 pezzi
Rg 303		Guarnizione di battuta - soluzione a doppia battuta - Materiale EPDM	2 Rotoli da 300 m
Rg 331		Guarnizione a muro o antirumore Materiale EPDM	3 Rotoli da 300 m
Rg 329		Guarnizione copricava Materiale EPDM	2 Rotoli da 150 m
Rg 404		Guarnizione per accoppiamento a nastro Materiale EPDM	1 Rotolo da 400 m
Rg 356		Guarnizione per bilico Materiale EPDM	2 Rotoli da 300 m
Rg 358		Spugna per Monoblocco	
Rg 323		Guarnizione isolamento soglia Materiale EPDM	

scala 1:1

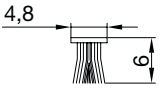
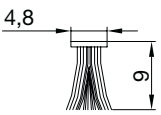
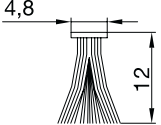
Rg 311		Guarnizione esterna vetro per vano da mm. 2,5 Materiale EPDM	2 Rotoli da 200 m
Rg 312		Guarnizione esterna vetro per vano da mm. 3,5 Materiale EPDM	2 Rotoli da 150 m
Rg 369		Guarnizione esterna vetro per vano da mm. 3,5 Materiale EPDM	2 Rotoli da 150 m
Rg 307		Guarnizione interna vetro per vano da mm. 2 Materiale EPDM	2 Rotoli da 300 m
Rg 320		Guarnizione interna vetro per vano da mm. 3 Materiale EPDM	2 Rotoli da 200 m
Rg 308		Guarnizione interna vetro per vano da mm. 4 Materiale EPDM	2 Rotoli da 150 m
Rg 321		Guarnizione interna vetro per vano da mm. 5 Materiale EPDM	2 Rotoli da 150 m
Rg 309		Guarnizione interna vetro per vano da mm. 6 Materiale EPDM	2 Rotoli da 100 m
48 x 600		Guarnizione a spazzola mm 4,8 x 6 Materiale polipropilene	4 Rotoli da 400 m
48 x 900		Guarnizione a spazzola mm 4,8 x 9 Materiale polipropilene	4 Rotoli da 200 m
48 x 1200		Guarnizione a spazzola mm 4,8 x 12 Materiale polipropilene	2 Rotoli da 200 m

scala 1:1

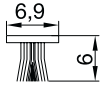
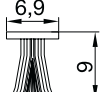
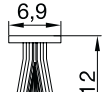
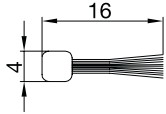
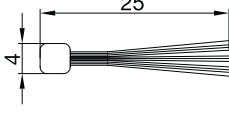
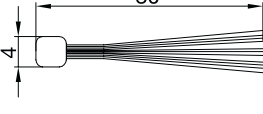
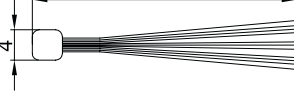
69 x 600		Guarnizione a spazzola mm 6,9 x 6 Materiale polipropilene	5 Rotoli da 100 m
69 x 900		Guarnizione a spazzola mm 6,9 x 9 Materiale polipropilene	4 Rotoli da 200 m
69 x 1200		Guarnizione a spazzola mm 6,9 x 12 Materiale polipropilene	2 Rotoli da 200 m
40 x 1600		Guarnizione sottozoccolo a spazzola mm 16 Materiale polipropilene	barre da 2 m
40 x 2500		Guarnizione sottozoccolo a spazzola mm 25 Materiale polipropilene	barre da 2 m
40 x 3000		Guarnizione sottozoccolo a spazzola mm 30 Materiale polipropilene	barre da 2 m
40 x 3500		Guarnizione sottozoccolo a spazzola mm 35 Materiale polipropilene	barre da 2 m